

# SBM-GLT-KNX

SBM-GLT-KNX for building management systems  
Installation and Operating Instructions

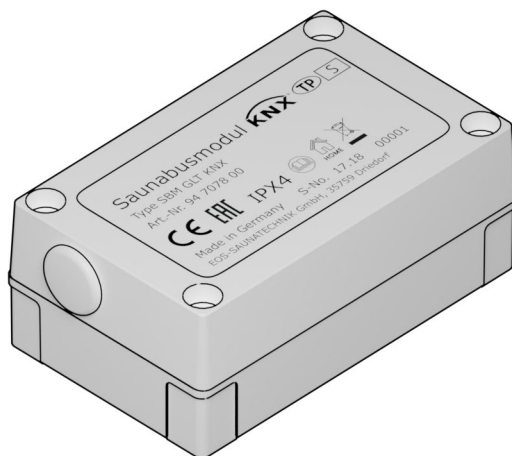

**Made in Germany**



Druck-Nr.:  
Stand:

2902 5021  
16/2019

# Documentation

## Manufacturer

EOS Saunatechnik GmbH

Schneiderstriesch 1

35759 Driedorf, Germany

Tel. +49 2775 82-0

Fax +49 2775 82-431

Web [www.eos-sauna.com](http://www.eos-sauna.com)

## Original installation instructions EN







Copyright for these installation instructions remains with EOS Saunatechnik GmbH.

Copyright as per DIN ISO 16016:

The copying and distribution of this document, as well as the use and communication of its contents without express authorisation, are not permitted. Compensation will be claimed in the event of infringements.

All rights reserved with regard to patent claims or submission of design or utility patent.

## Characters, symbols and illustrations

-  Additional information about an operating step
-  Cross-reference to a page
-  Read instructions
-  Result of a step
-  Table title
-  Title of figure

## Revision history

Date	Version	Description
6 May 2019	01.20	Programming of the cabin address has changed
March 2019	01.10	Safety instructions added
1 Jan. 2019	01.00	First version

# Contents

<b>Documentation</b> .....	2
<b>1 General safety instructions</b> .....	4
1.1 Safety levels .....	4
1.2 Mounting and electrical installation .....	5
1.3 Operator instruction .....	6
1.4 Standards and regulations .....	8
<b>2 Identification</b> .....	9
2.1 Unit specifications .....	9
2.2 Intended use .....	10
<b>3 Description of the unit</b> .....	11
3.1 Housing .....	11
3.2 Communication functions .....	12
3.3 Installation examples .....	14
3.4 Circuit boards .....	15
<b>4 Mounting and electrical installation</b> .....	16
4.1 Mounting the KNX Home-Modul .....	16
4.2 Connecting the KNX Home-Modul with the S-Bus .....	18
4.2.1 Connecting the S-Bus cable to the relay box or module	20
4.3 Configuring addresses for multi-cabin installations .....	21
4.4 KNX programming .....	22
4.5 Emotec, EmoStyle, EmoStyle i, Emotec IR, InfraStyle, InfraStyle i data communication .....	23
4.6 EmoTouch 3 data communication .....	25
<b>5 General terms and conditions of service</b> .....	26
<b>6 Disposal</b> .....	29

# 1 General safety instructions

## 1.1 Safety levels

Safety instructions and important operating instructions are classified according to ANSI Z535.6. Please familiarise yourself with the following terms and symbols:

### **DANGER**

#### **Danger**

Indicates a hazardous situation which, if not avoided, will result in death.

### **WARNING**

#### **Warning**

Indicates a hazardous situation which, if not avoided, could result in death or serious injury.

### **CAUTION**

#### **Caution**

Indicates a hazardous situation which, if not avoided, could result in minor or moderate injury.

### **NOTICE**

#### **Notice**

Indicates a hazardous situation which, if not avoided, will result in damage to the unit.

## 1.2 Mounting and electrical installation



These installation instructions are intended for qualified personnel familiar with the laws and regulations applicable to electrical installations at the installation site. Observe the following general safety instructions during mounting, configuration and commissioning of the product.

Refer also to the installation instructions for the units to which you connect the SBM-GLT-KNX. See also:

2.2 Intended use,  10

### **Risk to life and limb and risk of fire**

Risk to life and limb from electric shock and fire in the event of improper or faulty electrical connection. This risk also applies following completion of the installation work.

- ▶ The electrical installation of the relay box and other electrical systems or equipment with a fixed mains connection must only be performed by a trained electrician from an authorised electrical company.
- ▶ Observe the stipulations in VDE 0100 part 701.
- ▶ The system must be disconnected and removed entirely from the mains supply before commencing installation and repair work.
- ▶ The housing cover must only be removed by a specialist.
- ▶ Do not install control panels, relay boxes and modules in enclosed cabinets or wood panelling.

### 1.3 Operator instruction

During commissioning, the operator of the sauna cabin, infrared cabin or steam room must be instructed in relation to the following general safety instructions: The operator must be given a copy of the instructions for use.

#### **Risk of electric shock**

A risk to life and limb from electric shock and fire arises in the event of improper repair work. This risk also applies after work is completed.

- ▶ The housing cover must only be removed by a specialist.
- ▶ Repairs and installations must only be performed by a trained specialist.
- ▶ The system must be disconnected and removed entirely from the mains supply before commencing repair work.
- ▶ Use only original spare parts from the manufacturer.

#### **Risk of burns and chemical burns**

Touching hot parts may lead to skin burns and chemical burns of the skin.

- ▶ The operator must be familiar with the unit's hot parts and be able to identify them.
- ▶ The operator must be familiar with the settings for the heating period and understand how it is controlled.

#### **Health risks**

Spending time in a sauna cabin, infrared cabin or steam room can lead to serious health risks or even death for persons with health impairments.

- ▶ Persons with health impairments must consult a doctor before using a sauna cabin, infrared cabin or steam room.

## **Equipment damage due to overuse**

Excessive humidity in commercial sauna cabins, infrared cabins or steam rooms can lead to property damage.

- ▶ In a commercial sauna cabin, infrared cabin or steam room, the heating period must be set so that the heating switches off automatically after a specific period of time.
- ▶ If the heating does not switch off automatically after a defined heating period, cabin use must be supervised at all times.
- ▶ Inspect the cabin before each use.

## **Operation by children or persons with reduced mental capacity**

Children and persons with reduced mental capacity can be a risk.

- ▶ Children must be supervised to ensure they do not play with the unit.
- ▶ Operation of a sauna cabin, infrared cabin or steam room must not be started by children under 8 years of age.
- ▶ The settings for the heating time must only be used by children under 8 years of age if they are supervised by an adult.
- ▶ Operation of a sauna cabin, infrared cabin or steam room must not be started by persons with reduced mental capacity or limited physical or sensory abilities unless they are supervised or unless they have already been instructed in its use and understand the risks.
- ▶ Children and persons who have not received proper instruction must not clean or service the system.

## 1.4 Standards and regulations

The following standards, in their currently applicable versions, were observed during design and construction.

Local regulations also apply to the installation and operation of heating, sauna, and steam room systems.

Standard	Title
DIN EN 60335-1	Household and similar electrical appliances – Part 1: General requirements
DIN EN 60335-2-30	Household and similar electrical appliances – safety – Part 2-30: Particular requirements for room heaters
DIN EN 60335-2-53	Household and similar electrical appliances – safety – Part 2-53: Particular requirements for sauna heating appliances and infrared cabins
DIN EN 60335-2-96	Household and similar electrical appliances – safety – Part 2-96: Particular requirements for heating equipment
DIN EN 55014-1	Electromagnetic compatibility – Requirements for household appliances, electric tools and similar apparatus – Part 1: Emission
DIN EN 55014-2	Electromagnetic compatibility – Requirements for household appliances, electric tools and similar apparatus – Part 2: Immunity



## 2 Identification

The KNX sauna bus module for building management systems (SBM GLT KNX), also referred to as the KNX Home module, is used to connect sauna cabins, infrared cabins and steam rooms to a building management system.

### 2.1 Unit specifications

#### Nameplate

The nameplate is attached to the front of the upper part of the housing.

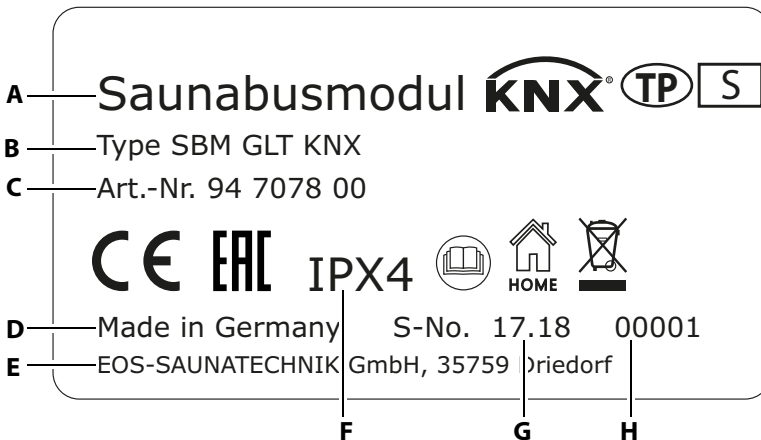

- |                            |                             |
|----------------------------|-----------------------------|
| <b>A</b> Name              | <b>E</b> Manufacturer       |
| <b>B</b> Model             | <b>F</b> Protection class   |
| <b>C</b> Item number       | <b>G</b> Manufacturing date |
| <b>D</b> Country of origin | <b>H</b> Serial number      |

 Nameplate (example)

#### Requirements for operation and storage

The KNX Home module must only be mounted outside of sauna cabins, infrared cabins and steam rooms. The mounting location must meet the following climate condition requirements:

- Ambient temperature during operation -10°C to 40°C
- Storage temperature: -20°C to 60°C

The following control panels support this control:

- Emotec, Emotec IR (software release R. 3.50 or higher)
- EmoStyle, InfraStyle (software release R. 3.50 or higher)
- EmoStyle i, InfraStyle i (software release R. 3.50 or higher)
- EmoTouch 3 (also SteamRock Premium, software release R. 2.08 or higher)

Check the software release of your control panel. Perform an update if necessary.

## 2.2 Intended use

The KNX Home module is intended to be connected to a building management system. In conjunction with a suitable control unit, it serves to remotely control selected functions in sauna cabins, infrared cabins and steam rooms.

This type of remote control is designated as a telecontrol\* as per EN 60355-1. Therefore, an additional safety measure is required as per EN 60335-2-53 when used in conjunction with a sauna cabin or an infrared heat cabin. This safety measure could be a protective cover on the heater, a door supervision device or another type of technical equipment. Always ensure that a safety measure of this nature is installed.

\*Telecontrol = setting up, controlling and/or regulating a device with a command that can be given outside of the visual range of a device, whereby the transmission media such as telecommunication, audio engineering or bus systems are used; also included are pre-set timers and weekly timers. (from EN 60335-1)

## Foreseeable misuse

The following are considered instances of foreseeable misuse:

- The connecting cables are connected incorrectly.
- The cabin addresses are programmed incorrectly.
- The unit is operated after technical or other modifications are made to the relay box.
- The unit is operated by children or persons with reduced mental capacity or by persons who have not been thoroughly instructed in its use.

## 3 Description of the unit

The KNX Home module allows you to monitor and control cabin-control functions using a building management system. This enables monitoring of individual cabins or a complete multi-cabin installation.

In a multi-cabin installation, a KNX Home module is connected for each cabin.

The KNX Home module transfers data between the sauna bus and the KNX bus in both directions. Its use is configured using the building management system. The SBM-GLT-KNX should be operated with software version ETS5 or higher.

### Scope of delivery

The SBM-GLT-KNX is encased in a plastic housing. The housing completely encloses the circuit board and the electronics.

The following components are included in the scope of delivery:

- SBM-GLT-KNX
- Wood screws 4 x 25 mm
- 4 anchors
- S-Bus cable 10 m, with 2 RJ12 plugs

### 3.1 Housing

Two circuit boards are used to establish a connection from the sauna bus to the KNX bus. The plastic housing completely encloses the circuit boards. Power is supplied via the bus line.

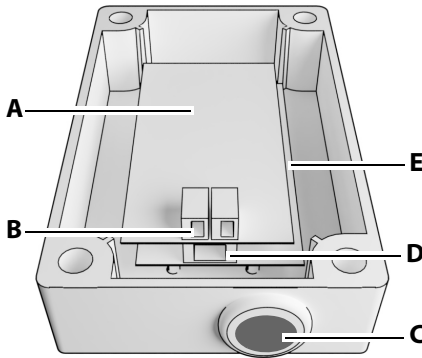

- A** KNX circuit board  
**B** Terminals for KNX lines  
**C** Cable feed opening  
**D** S-Bus connection (S-Bus)  
**E** S-Bus circuit board (bottom)

 Top piece of KNX Home module

### 3.2 Communication functions

The KNX Home module provides the following communication functions. The data type is defined by the KNX association.

Settings made using a setpoint enable changes during operation. The actual value supplies current data from the cabin. A feedback mechanism sends a signal when changes are made in the cabin.

No.	Name	Function	Data type	Selection	Setting
0	Cabin lighting	Switch	1 bit ON/OFF	Control > cabin lighting	On/Off or 0–100%
1	Sauna	Switch	1 bit ON/OFF	Control > Temperature in the sauna	On/Off or SET-POINT
2	Vaporiser tank	Switch	1 bit ON/OFF	Control > Vaporiser tank	On/Off or SET-POINT
3	Light setpoint	Setpoint	1 byte	Control > cabin lighting	0–100%
4	Temperature setpoint	Setpoint	2 bytes	Control > Temperature in the sauna	SETPOINT 0–65,535

No.	Name	Function	Data type	Selection	Setting
5	Humidity set-point	Setpoint	2 bytes	Control > Vaporiser tank	SETPOINT 0–65,535
6	Actual light value	Measurement	1 byte	Measurements > cabin lighting	On/Off
7	Actual temperature value	Measurement	2 bytes	Measurements > Temperature in the sauna	On/Off
8	Actual humidity value	Measurement	2 bytes	Measurements > Temperature in the sauna	On/Off
9	Light feedback	Switch feedback	1 bit ON/OFF	Control > cabin lighting	On/Off or 0–100%
10	Sauna feedback	Switch feedback	1 bit ON/OFF	Control > Temperature in the sauna	On/Off or SET-POINT
11	Vaporiser tank feedback	Switch feedback	1 bit ON/OFF	Control > Vaporiser tank	On/Off or SET-POINT
12	Potential-free contact (PFC) switch	Switch	1 bit ON/OFF	Control > Potential-free contact	On/off
13	PFC feedback	Switch feedback	1 bit ON/OFF	Control > Potential-free contact	On/Off

### 3.3 Installation examples

Individual functions can be activated in a standard installation, e.g. Sauna on/off, Cabin lighting on/off.

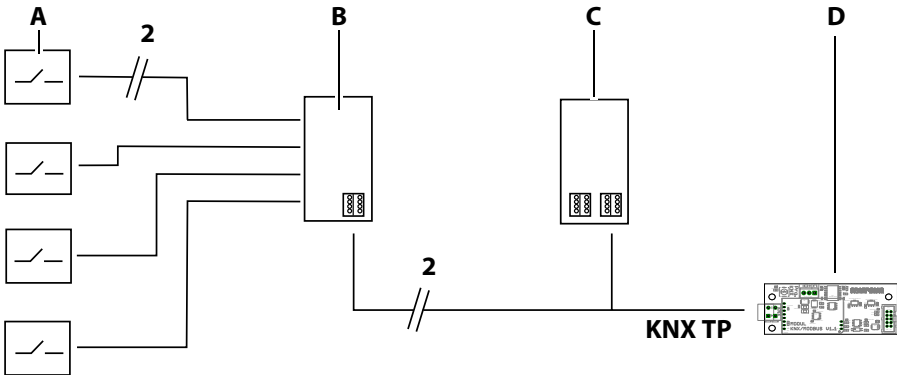

**A** Switch, e.g. at reception

**B** KNX interface

**C** Power supply

**D** Circuit board/KNX module

☒ Installation for switch functions

In an advanced installation, the data can be transferred to an app via a router and the activated functions can then be operated using the app.

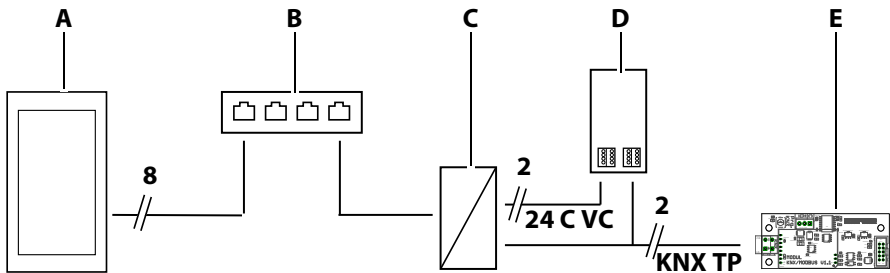

**A** Touch panel/smartphone

**B** Switch/router

**C** KNX IP router

**D** KNX power supply

**E** Circuit board/KNX module

☒ Installation with monitoring and switch functions

### 3.4 Circuit boards

The housing contains two combined circuit boards. The upper circuit board establishes a connection to the building management system, while the lower circuit board is used for sauna control.

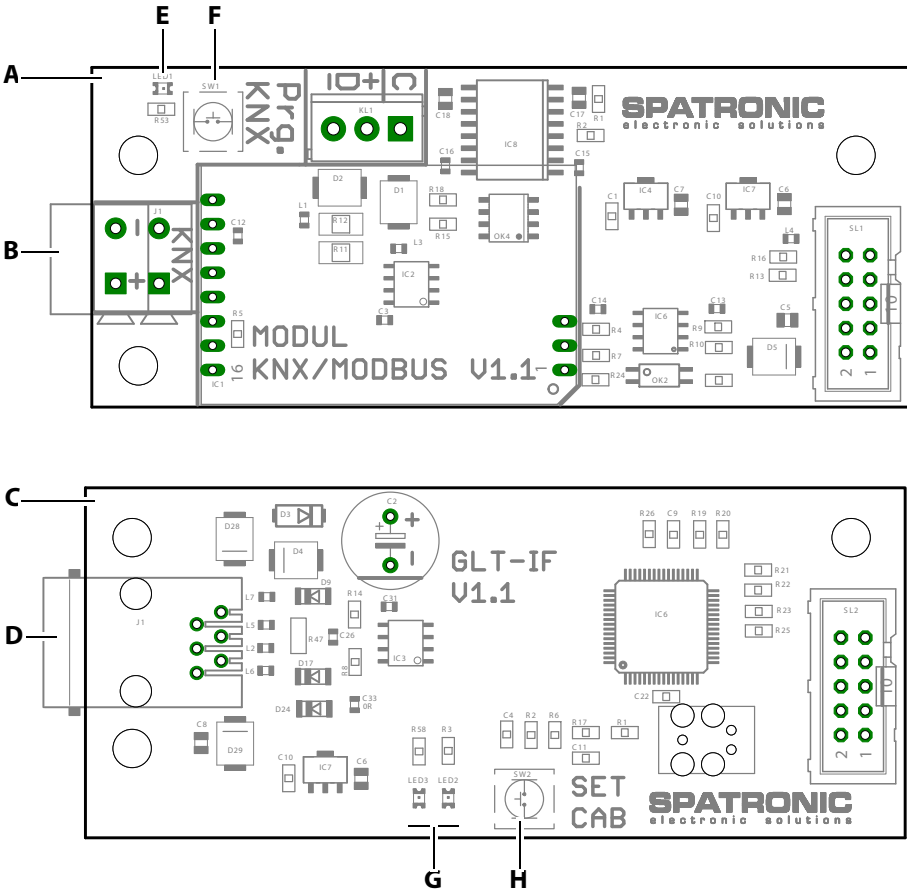

**A** Upper circuit board for KNX bus connection

**B** Terminals for KNX bus

**C** Lower circuit board for S-Bus connection

**D** S-Bus connection

**E** KNX programming LED

**F** KNX programming button

**G** LEDs for S-Bus status display

**H** Programming button for S-Bus cabin address

 KNX module circuit boards

## 4 Mounting and electrical installation

This chapter describes how to mount and wire the SBM-GLT-KNX.

### NOTICE

#### Equipment damage

Corrosive environments or environments with high levels of saline in the air could damage lines and circuit boards.

- ▶ Only use the SBM-GLT-KNX in a non-corrosive environment.

### 4.1 Mounting the SBM-GLT-KNX

Tools + hardware

- Drill
- Wood screws 4 x 25 mm
- Mounting on a fixed wall: Screws 4 x 25 mm and suitable anchors

The SBM-GLT-KNX is intended to be mounted on the outer wall of the cabin or in the utility room. The maximum cable length between the relay box and the SBM-GLT-KNX is 10 m.

#### ▶ Mounting the housing

- 1 Drill 2 holes at the top and another 2 at the bottom of the wall.  
① The housing can be mounted either vertically or horizontally.

Horizontal distance between drill holes: 63.5 mm

Vertical distance between drill holes: 113.5 mm

- 2 Use anchors if necessary.
- 3 Loosen the housing screws on the cover.



- 4 Attach the bottom piece to the mounting location using the screws provided.

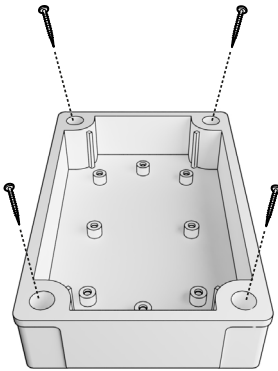

 Bottom piece of SBM-GLT-KNX housing

**► Wiring the connections**

- 1 Feed the connection cable through the opening on the top piece of the housing.

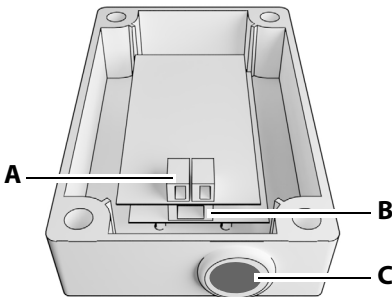

**A** Terminal block for KNX lines      **C** Cable feed opening

**B** RJ12 jack for sauna bus line

 Upper piece of SBM-GLT-KNX housing

- 2 Plug the S-Bus line into the RJ12 jack.
- 3 Plug the KNX lines into the terminal block.
  - ⓘ Carefully pull back any excess cable length or place it in a loop in the bottom piece of the housing.

- 4 Configure the S-Bus address if necessary. See:  
4.3 Configuring addresses for multi-cabin installations, [📄 21](#)
- 5 Program the KNX address and user software. See:  
4.4 KNX programming, [📄 22](#)
- 6 When all settings have been completed, place the top piece of the housing on top and attach it using the 4 housing screws.

## 4.2 Connecting the SBM-GLT-KNX with the S-Bus

On the circuit board of the relay box or add-on module, you will find 2 connection jacks for the S-Bus lines. Four connection jacks are provided with the SteamRock Premium.

Sample installation:

- In a standard installation, the control panel and the SBM-GLT-KNX are plugged into the relay box.

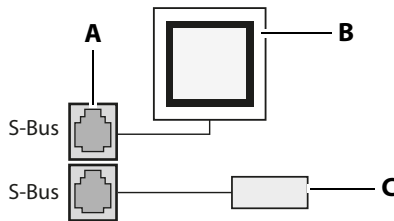

- A** S-Bus connections on the relay box    **C** SBM-GLT-KNX  
**B** Control panel

 Standard installation

- In the advanced installation, the control panel and the add-on module are connected to the relay box. The SBM-GLT-KNX is connected to the add-on module.

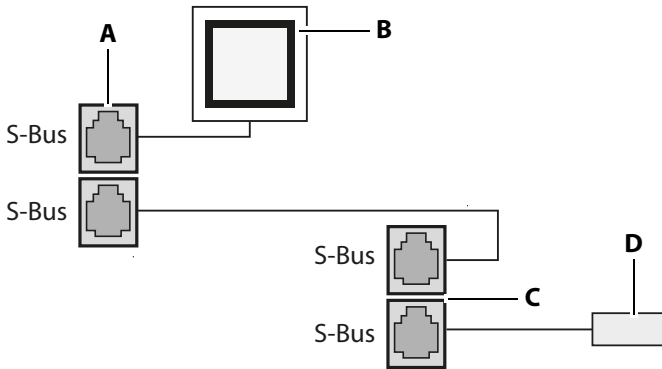

- A** S-Bus connections on the relay box
- B** Control panel
- C** Add-on module circuit board
- D** SBM-GLT-KNX

 Advanced installation

- In the case of a multi-cabin installation with the EmoTouch 3 control panel, the SBM-GLT-KNX must be installed in the same S-Bus segment as the relay box that is to be controlled. It may also be necessary to use an S-Bus plug-in module. The S-Bus address of the cabin to be controlled must be configured in the SBM-GLT-KNX.

## 4.2.1 Connecting the S-Bus cable to the relay box or module

### NOTICE

#### Incorrect data transfer due to incorrect installation

The software does not recognise the SBM-GLT-KNX. Data is transferred incorrectly.

- ▶ Only plug S-Bus cables into S-Bus jacks on the circuit board.
- ▶ Connect only one SBM-GLT-KNX per cabin.

#### ▶ Connecting the S-Bus

- 1 DANGER! Ensure that there is no voltage present on the circuit board. Disconnect the circuit board entirely from the mains supply.
- 2 Remove the housing cover.
- 3 Plug the plug into an S-Bus jack on the circuit board.

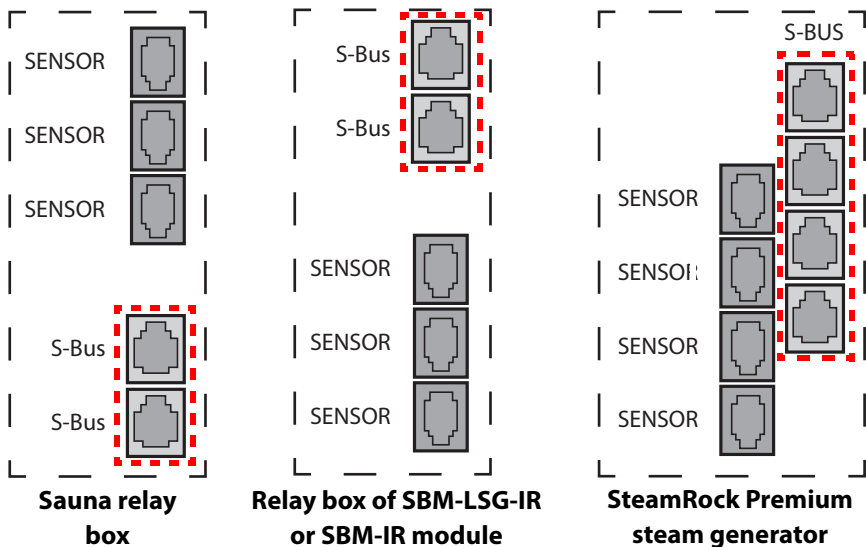

 Circuit board sections for S-Bus jacks

- 4 Replace the housing cover on the relay box and switch the power supply back on.

### 4.3 Configuring addresses for multi-cabin installations

You only need to configure S-Bus addresses in a multi-cabin installation with an EmoTouch 3 control panel. The S-Bus address of the cabin you want to control must be configured in the SBM-GLT-KNX for this purpose. The Emotec, EmoStyle, EmoStyle i, Emotec IR, InfraStyle and InfraStyle i always require the cabin address 1.

#### ► Programming the address

- 1 Keep the programming button pressed for approx. 5-6 seconds until the red LED lights up.
  - ① Programming mode is then active. The green LED light goes off.

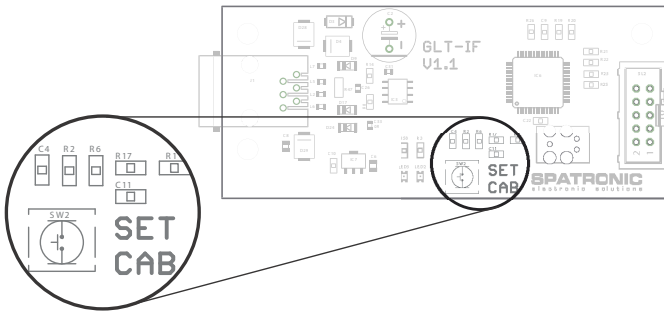

- 2 Briefly but firmly press the programming button once.
- 3 Wait until the green LED flashes and count how many times it flashes.
  - The green LED flashes 1 to 8 times, depending on the new cabin address, for example twice for cabin 2.
- 4 Repeat steps 2 and 3, until the desired cabin address has been set.
  - ① Note that each time you press the programming button, the cabin address increases by one. Once address 8 is reached, the count starts over with address 1.
  - If the button is not pressed for approx. 15 seconds, programming mode ends. The red LED goes off and the green LED starts flashing. The new address is saved.

- 5 To ensure that the address has been configured successfully, search for the *M.-HOME* entry in the Firmware version menu of the EmoTouch 3 control panel.
  - ① If the *M.-HOME* entry exists, the SBM-GLT-KNX was detected successfully.
- 6 If the *M.-HOME* entry is not displayed, repeat the programming step.

#### 4.4 KNX programming

The SBM-GLT-KNX should be operated with software version ETS5 or higher. In the ETS project, a corresponding unit must be created and configured.

##### ► Programming the KNX address

- 1 Press the KNX programming button.
  - ① Programming mode is activated. The programming LED lights up.

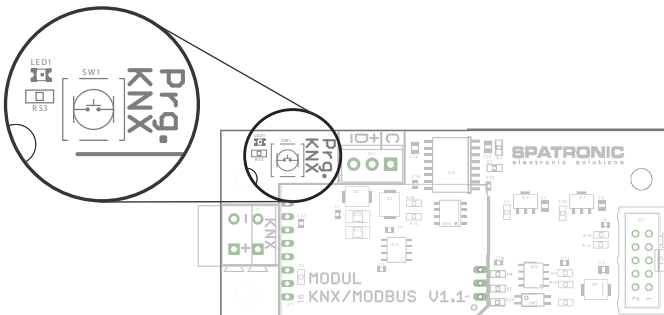

- 2 Load the physical address into the SBM-GLT-KNX.
- 3 Load the user software into the SBM-GLT-KNX.
- 4 Check the display of the building management system to verify that the cabin is displayed.
- 5 Close the SBM-GLT-KNX housing.

## 4.5 Emotec, EmoStyle, EmoStyle i, Emotec IR, InfraStyle, InfraStyle i data communication

When the building management system and the SBM-GLT-KNX are connected, you must define the transfer protocol. Familiarity with the general operating functions is assumed.

### ► Configuring the transfer protocol

1  : Select and confirm by pressing and holding until the code entry is displayed.

a) Emotec: Press and hold the jog dial.

b) InfraStyle, InfraStyle i: Press and hold the Enter icon.

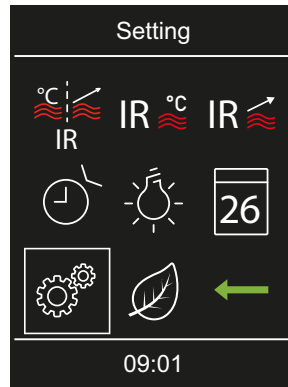
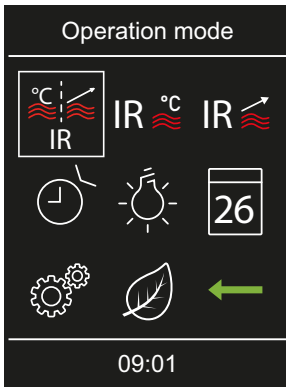

2 Enter code **5349** and confirm.

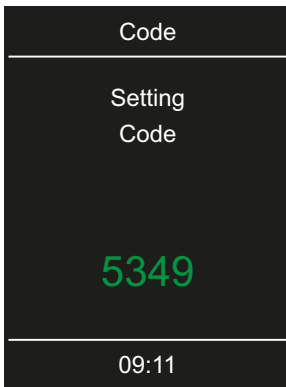

① Increase or decrease the individual numbers and confirm. Confirmed numbers appear green.

- 3  : Select and confirm.



- 4  : Select and confirm.



- 5 Confirm your entry with .







## 4.6 EmoTouch 3 data communication

When the building management system and the SBM-GLT-KNX are connected, you must define the transfer protocol. Familiarity with the general operating functions is assumed.

### ► Configuring the transfer protocol

- 1 Select the cabin.
- 2 Tap and hold  for 3 seconds.
- 3 Enter code **5349** and confirm.
- 4 Tap  twice.
- 5 Select the KNX Enable check box.

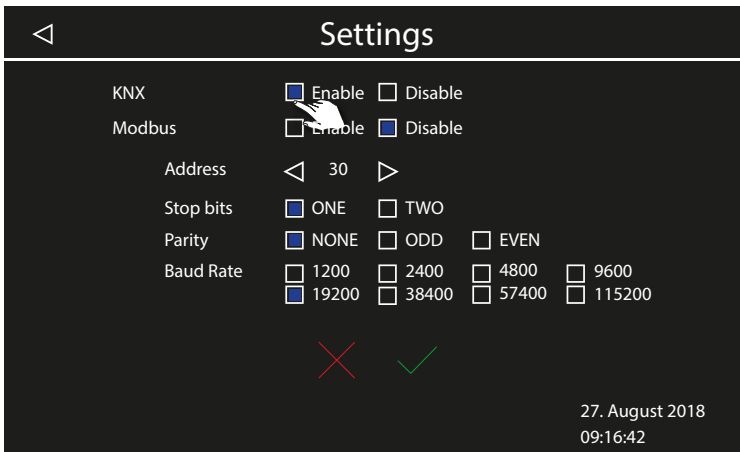

① You are not required to set any further values for the KNX transfer protocol.

- 6 Confirm your setting with .

## **5 General terms and conditions of service**

(T&C, Dated 08-2018)

### **I. Scope**

Unless otherwise agreed in writing for specific instances, these terms and conditions of service shall apply to service operations, including reviewing and remedying complaints. All our existing or future legal relationships shall be governed solely by the following terms and conditions of service. We do not recognise any of the customer's conflicting terms and conditions unless we have given our express written consent to their applicability.

We hereby expressly object to any of the customer's terms and conditions included in the customer's General Terms and Conditions of Business or order confirmation. Unconditional acceptance of order acknowledgments or deliveries shall not be construed as any form of acknowledgment of such terms and conditions. Ancillary agreements or amendments must be confirmed in writing.

### **II. Costs**

The customer shall bear the following costs in connection with services rendered:

- Mounting/dismantling and electrical (de-)installation
- Transportation, postage and packaging
- Function testing and troubleshooting, including inspection and repair costs

There shall be no third-party billing.

### **III. Performance and cooperation obligations**

The customer shall provide assistance free of charge to the manufacturer in rendering services.

In the case of a warranty claim, the manufacturer shall provide replacement parts necessary for servicing free of charge.

#### **IV. Service visit by the manufacturer**

Services rendered on site by an employee of the manufacturer must be agreed in advance.

If the main reason for the service visit is not the fault of the manufacturer, any costs incurred shall be charged to the customer after the service visit and must be paid by the customer in full within the agreed payment term.

#### **V. Liability**

The manufacturer shall assume liability in accordance with the currently applicable statutory regulations. All our products are packaged in such a way that the individually packed goods (pallets) can be shipped.

We wish to point out that our packaging is not suitable for individual shipments via parcel post. The manufacturer shall accept no liability for damages incurred as a result of improper packaging in an individual shipment.

#### **VI. Manufacturer's warranty**

The manufacturer's warranty shall apply only if installation, operation and maintenance have been carried out in full accordance with the manufacturer's specifications in the installation and operating instructions.

- The warranty period shall commence from the date on which proof of purchase is provided and shall be limited, in all cases, to 24 months.
- Warranty services shall be performed only if proof of purchase of the equipment can be presented.
- Any and all warranty claims shall become void if modifications are made to the equipment without the manufacturer's express consent.
- Any warranty claim shall likewise become void in the case of defects that arise due to repairs or interventions made by unauthorised persons or due to improper use.
- In the case of warranty claims, the serial and article numbers must be provided, together with the unit designation and a meaningful description of the error.
- This warranty shall cover defective equipment parts, with the exception of normal wear parts. Wear parts shall include, for example, light sources, glass elements, tubular heating elements and sauna heater stones.

- Only original replacement parts may be used within the warranty period.
- Service visits made by third parties shall require a written order issued by our service department.
- The equipment in question shall be sent to our service department by the customer at the customer's own expense.
- Electrical assembly and installation work, including service visits and parts replacements, shall be carried out at the customer's expense; costs shall not be borne by the manufacturer.

Complaints in respect of our products shall be reported to the responsible distributor and shall be handled exclusively by said distributor.

The manufacturer's General Terms and Conditions of Business, in the version available at [www.eos-sauna.com/agb](http://www.eos-sauna.com/agb), shall apply in addition to the foregoing terms and conditions of service.

## 6 Disposal



Electrical devices that are no longer needed must be recycled at a recycling station as per EU guideline 2012/19/EU or as per the Electrical and Electronic Equipment Act (ElektroG).

Observe local provisions, laws, regulations, standards and directives when disposing of the unit.



Do not dispose of the unit with household waste.



### Packaging

The packaging of the SBM-GLT-KNX can be completely separated for disposal and recycled. The following materials are used in the packaging:

- Used paper/cardboard
- Plastic foil

### Electronic waste

Electronic waste must be disposed of at the designated local collection point for electronic waste.







## **Service address**

EOS Saunatechnik GmbH

Schneiderstriesch 1

35759 Driedorf, Germany

Tel. +49 2775 82-0

Fax +49 2775 82-431

Web [www.eos-sauna.com](http://www.eos-sauna.com)

Store this address with the Installation and Operating Instructions in a safe place.

Please always provide us with nameplate data, such as model, item number and serial number so we can provide fast and efficient support.

## **Date of sale**

## **Stamp/retailer signature:**